

P 240 A *Smart*

PALFINGER

LIFETIME EXCELLENCE

THE BEST SOLUTION FOR EFFICIENT OPERATIONS IN TERMS OF PERFORMANCE, SIZE AND RELIABILITY



P 240 A *Smart*

WORKING DIAGRAMS

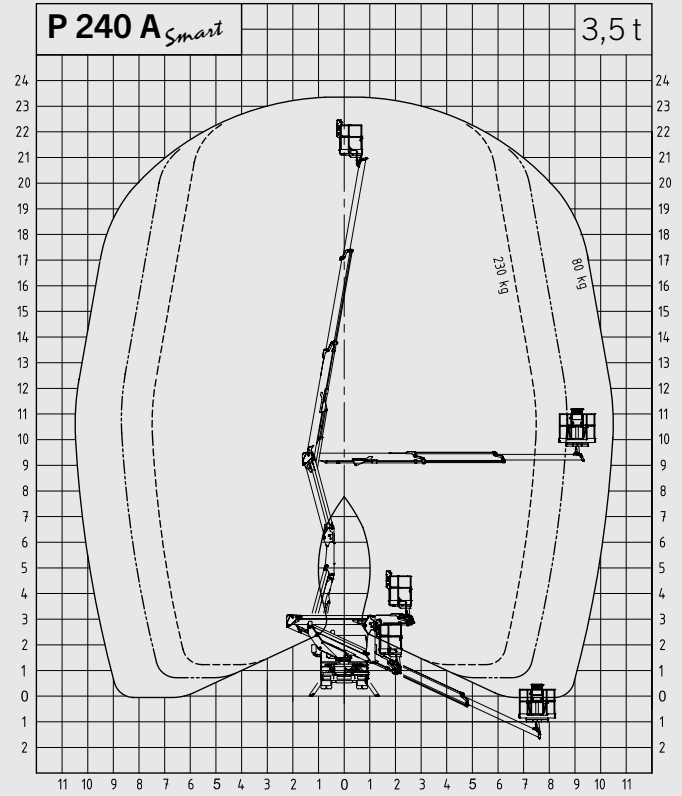
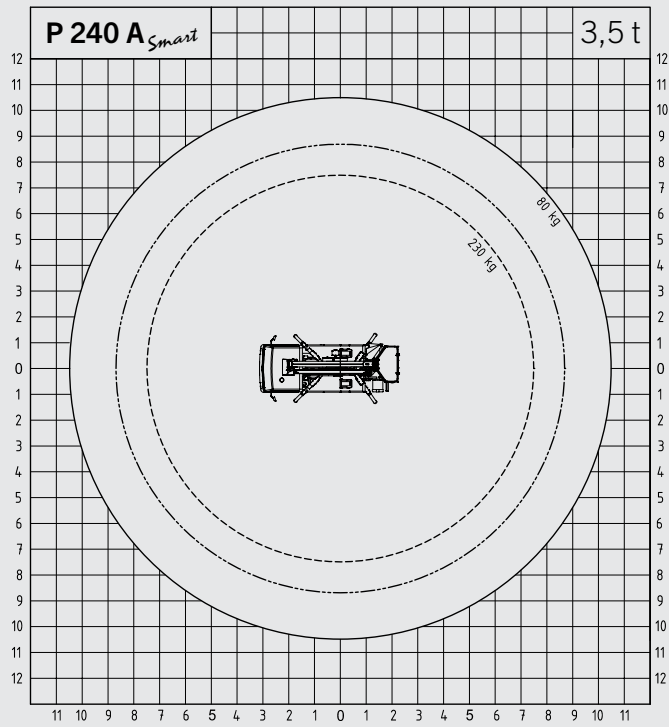

DIMENSIONS

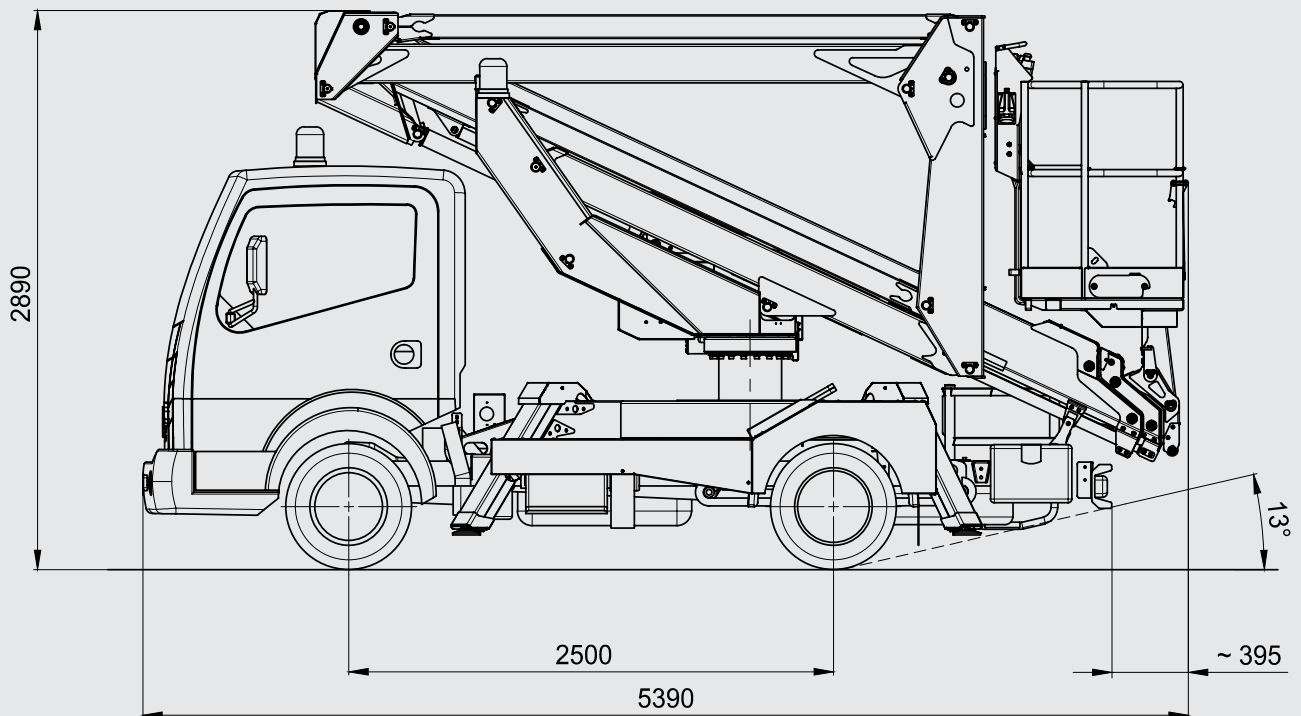



- Shortest machine in its class
- Small & clever for use in city centres
- Compact design and easy operation
- Fully hydraulic operation
- Ergonomic design
- Flexible access to heights thanks to combination of joint and telescope
- High manoeuvrability thanks to the extremely short wheelbase
- Safe working
- Professional PALFINGER quality

TECHNICAL SPECIFICATIONS

Max. working height	23.2 m
Max. basket bottom height	21.2 m
Max. outreach	10.2 m
Angle of main boom	-25° to + 80°
Rotation angle of turntable	370°
Rotation angle of basket	2 x 90°
Basket load	230 kg
Size of basket	1.4 x 0.85 x 1.1 m
Height in transport position	2.89 m
Width in transport position	2.1 m
Total length	5.39 m
Total weight	3350 kg

OPTIONAL

Fiberglass basket
Insulation 1000 V
Aluminium Side bars 200 mm
Electric motor 230 V
Working adjustable light 60 W on the basket
Customised paintwork boom

LIFETIME EXCELLENCE

THE RESULT IS **PALFINGER ACCESS PLATFORMS** FEATURING THE MOST STATE-OF-THE-ART HEIGHT TECHNOLOGY THAT ACHIEVE ABSOLUTE PEAK PERFORMANCES, EVEN WHEN CONFRONTED WITH THE MOST DIFFICULT OF JOBS IN PRACTICE. **DEVELOPED FOR THE GLOBAL MARKET, DESIGNED FOR THE FUTURE.**

BETTER
SOLUTIONS

BETTER
EFFICIENCY

BETTER
ERGONOMICS

HIGHER VALUE
RETENTION

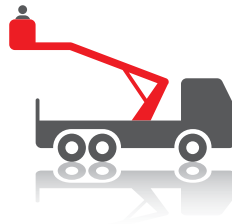

HIGHER
AVAILABILITY

HIGHER
SERVICEABILITY

BETTER
ECOLOGY

MORE
RELIABILITY

For further information please visit: www.palfinger.com/thebrand